

ITEM NO.	DESCRIPTION	QTY.	CODE	LENGTH(mm)
1	560MM PIPE FLOAT SET	2	MTF560	1200
KIT	STANDARD GALVANISED FASTENER KIT INCLUDES:	1	MTF-GK-08	
2	12MM BOLTS	4		350
3	12MM NUTS	4		
4	BOLT RETAINER INSERTS	8		
5	12MM WASHERS	8		
OPTIONAL	STAINLESS STEEL FASTENER KIT	1	MTF-SK-08	350
OPTIONAL	RUBBER REDUCER TO REDUCE 20MM - SET	2	MTF-B-15H	880
OPTIONAL	RUBBER REDUCER TO REDUCE 40MM - SET	4	MTF-B-15F	880

NOTES:

MATERIAL:
LLDPE MATERIAL DESIGNED SPECIFICALLY FOR ROTATIONAL MOULDING APPLICATIONS DELIVERING A HIGH ESCR, CHEMICAL RESISTANCE, STIFFNESS AND TOUGHNESS WHICH IS UV STABILISED TO PROVIDE PROLONGED OUTDOOR PROTECTION IN HARSH CONDITIONS.

DIMENSIONS:
DIMENSIONS MAY VARY SLIGHTLY DUE TO THE SHRINKAGE NATURE OF POLYETHYLENE.

REFER TO TECHNICAL DATA SHEET FOR FURTHER PRODUCT DETAILS AND INSTALLATION INFORMATION.

RUBBER REDUCERS.
- 2x RUBBER STRIPS IN SET TO REDUCE BY 20MM (FIT IN ONE FLOAT HALF)
- 4x RUBBER STRIPS IN SET TO REDUCE BY 40MM (FIT IN BOTH FLOAT HALVES)

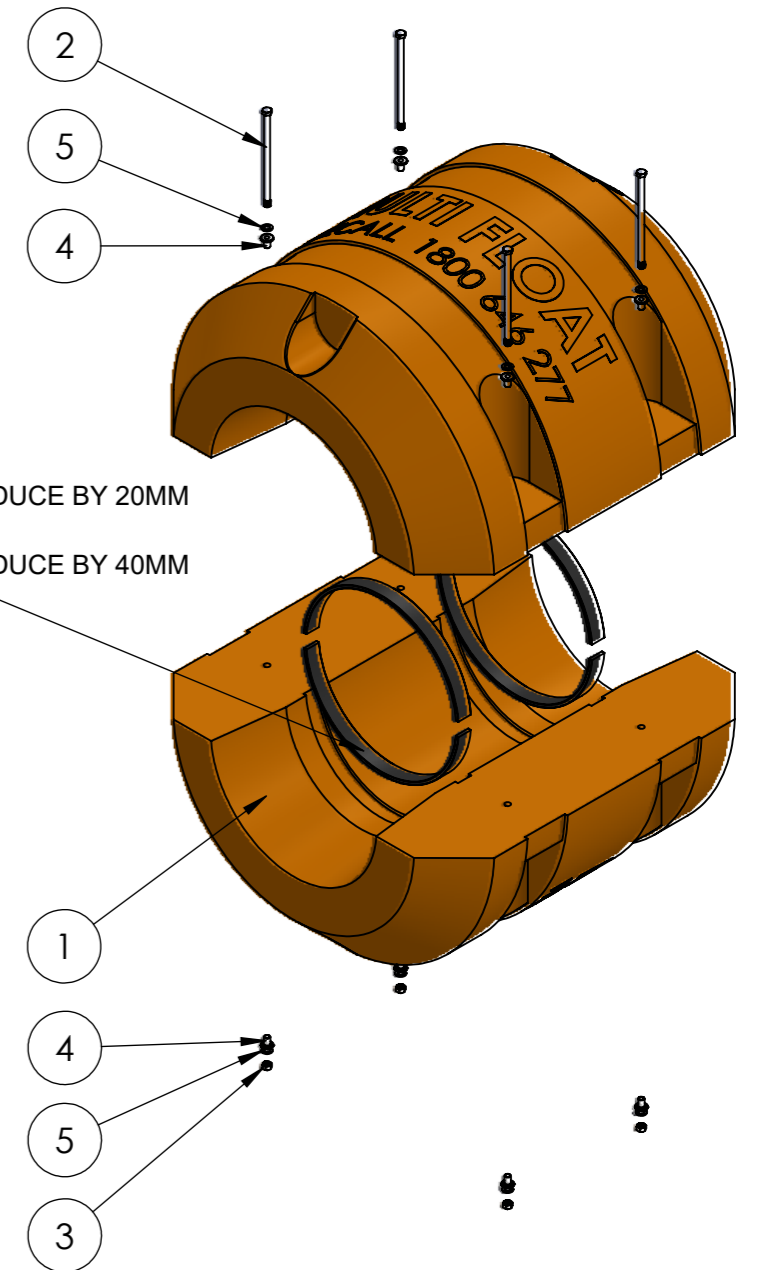

PIPE FLOAT SET WEIGHT: 80.5kg

REV	DESCRIPTION	DWN	CHK	APP	DATE
02	UPDATED TEMPLATE AND TABLE	JT	RB	MJ	14.11.23
01	ISSUED FOR CONSTRUCTION	MI			15.07.22

MATERIAL	LLDPE	DWN	JT
COLOUR/ FINISH	-	CHK	RB
S.G.	-	APP	MJ
		SCALE: NTS	

STOCK CODE	MTF560
PRODUCT	560mm HOSE FLOAT