

ITEM NO.	DESCRIPTION	QTY.	CODE	LENGTH(mm)
1	160MM PIPE FLOAT SET	2	MTF160	900
KIT	STANDARD GALVANISED FASTENER KIT INCLUDES:	1	MTF-GK-03	
2	12MM BOLTS	4		240
3	12MM NUTS	4		
4	BOLT RETAINER INSERTS	8		
5	12MM WASHERS	8		
OPTIONAL	STAINLESS STEEL FASTENER KIT	1	MTF-SK-03	240
OPTIONAL	RUBBER REDUCER TO REDUCE 20MM - SET	2	MTF-B-06H	160
OPTIONAL	RUBBER REDUCER TO REDUCE 40MM - SET	4	MTF-B-06F	160

NOTES:

MATERIAL:
LLDPE MATERIAL DESIGNED SPECIFICALLY FOR ROTATIONAL MOULDING APPLICATIONS DELIVERING A HIGH ESCR, CHEMICAL RESISTANCE, STIFFNESS AND TOUGHNESS WHICH IS UV STABILISED TO PROVIDE PROLONGED OUTDOOR PROTECTION IN HARSH CONDITIONS.

DIMENSIONS:
DIMENSIONS MAY VARY SLIGHTLY DUE TO THE SHRINKAGE NATURE OF POLYETHYLENE.

REFER TO TECHNICAL DATA SHEET FOR FURTHER PRODUCT DETAILS AND INSTALLATION INFORMATION.

RUBBER REDUCERS.
- 2x RUBBER STRIPS IN SET TO REDUCE BY 20MM (FIT IN ONE FLOAT HALF)
- 4x RUBBER STRIPS IN SET TO REDUCE BY 40MM (FIT IN BOTH FLOAT HALVES)

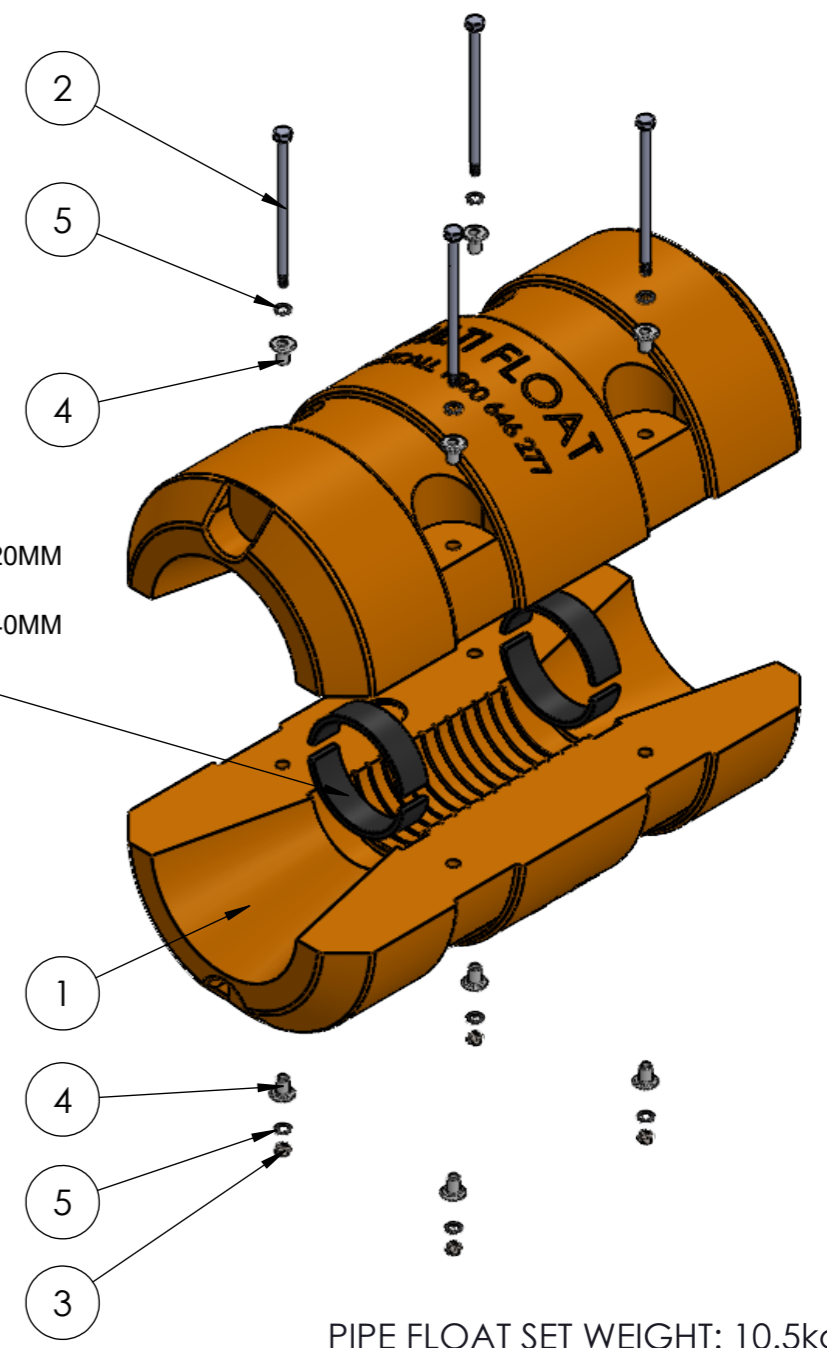
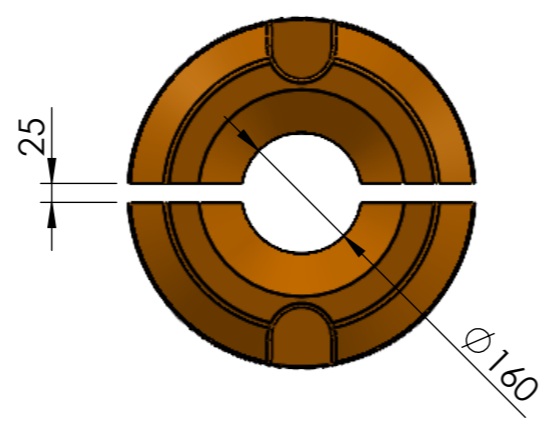
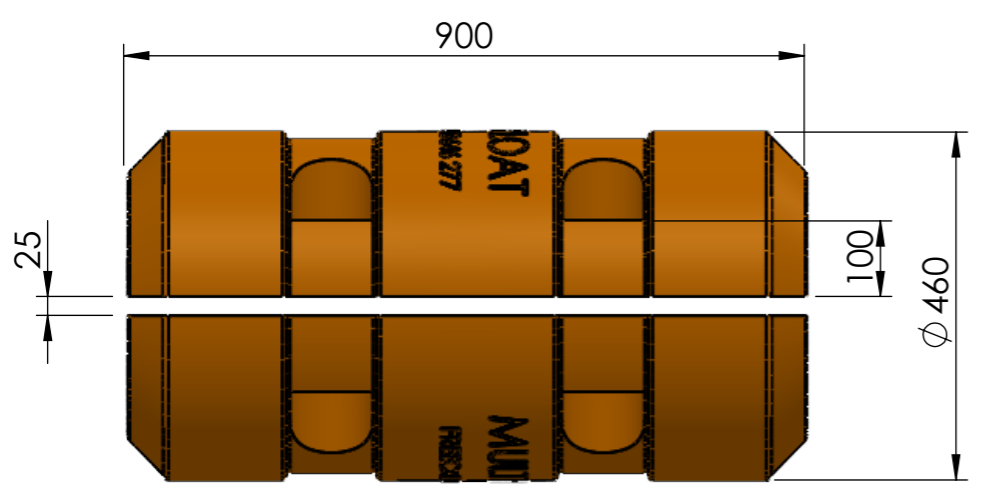
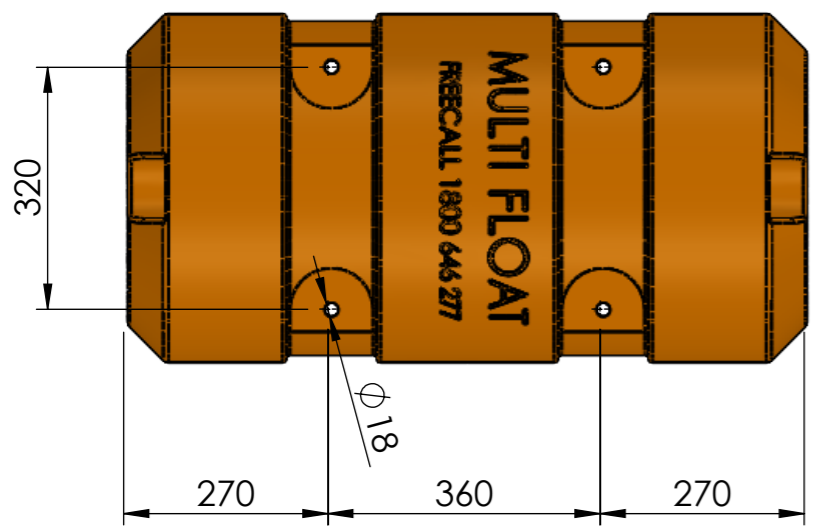

PIPE FLOAT SET WEIGHT: 10.5kg

REV	DESCRIPTION	DWN	CHK	APP	DATE
02	UPDATED TEMPLATE AND TABLE	JT	RB	MJ	13.11.23
01	ISSUED FOR CONSTRUCTION	MI			14.07.22

MATERIAL	LLDPE
COLOUR/ FINISH	-
S.G.	-

DWN	JT
CHK	RB
APP	MJ
SCALE: NTS	

STOCK CODE	MTF160
PRODUCT	160mm HOSE FLOAT

PROPRIETARY. Neither this document nor its contents may be used or reproduced in any manner without the written authorisation of COERCO. Unless otherwise noted all dimensions are in millimetres.

COERCO
23 Harris Rd, Malaga Western Australia 6090

Phone: 1800 646 277
E-mail: info@coerco.com.au

SHEET 1 OF 1	DWG NO.	MTF160_GA_001	REV.	02
--------------	---------	----------------------	------	-----------